

naam:.....

# 1. Schrijf de letter netjes over.



i i i i i i i i i . . . .

# 2. Hoor je de letter 'i'? Zet een kruisje in het juiste vak.

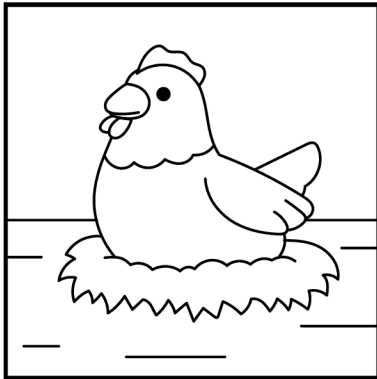

--	--	--

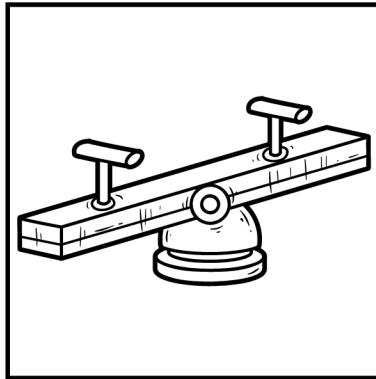

--	--	--

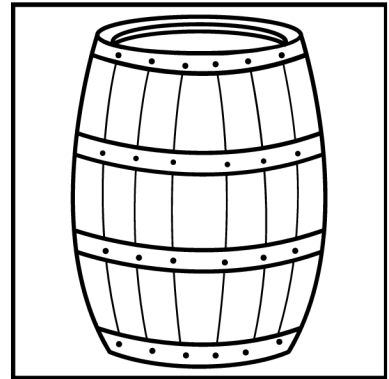

--	--	--

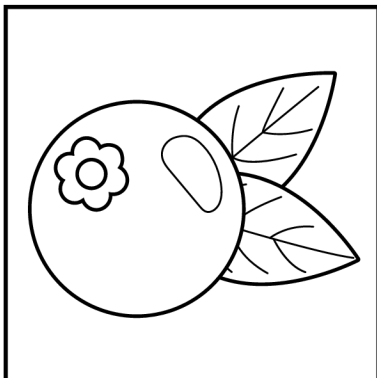

--	--	--

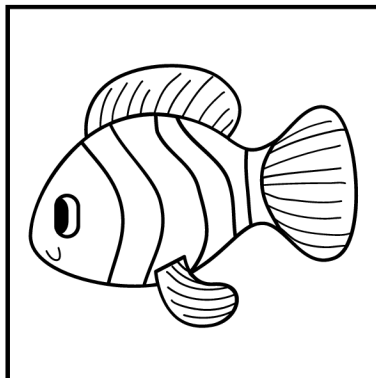

--	--	--

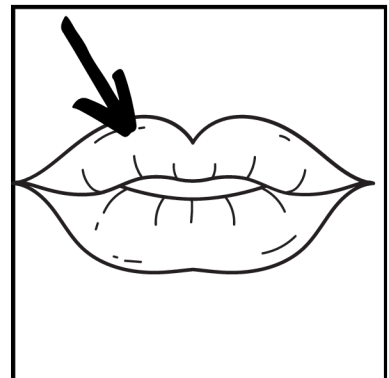

--	--	--

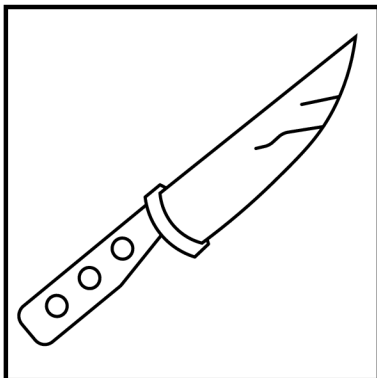

--	--	--



--	--	--

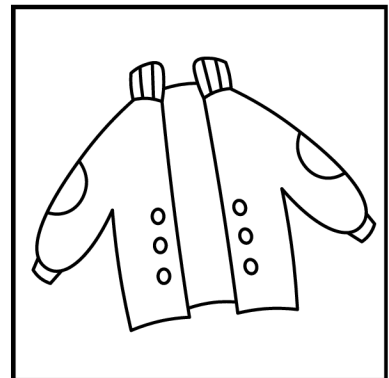

--	--	--

naam:.....

# 1. Schrijf de letter netjes over.

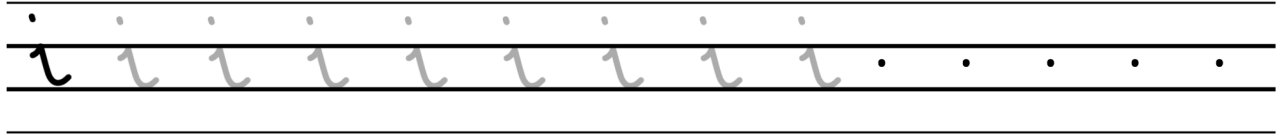

# 2. Hoor je de letter 'i'? Zet een kruisje in het juiste vak.

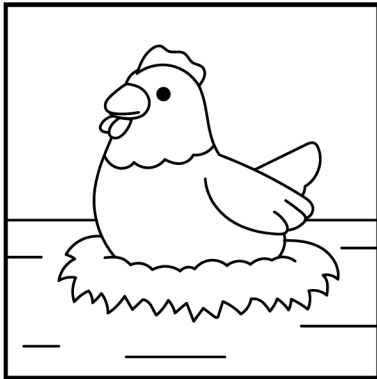

--	--	--

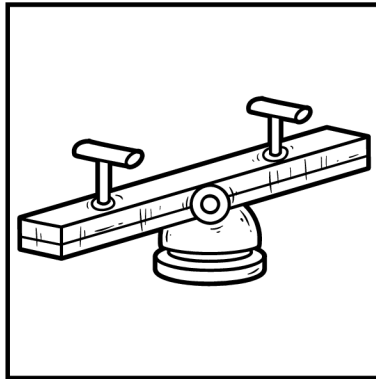

--	--	--

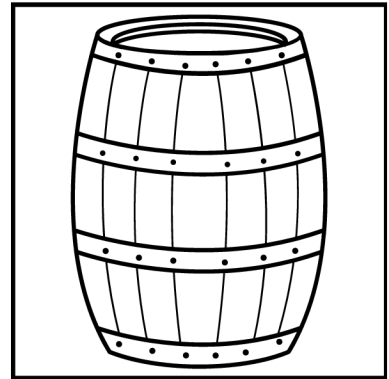

--	--	--

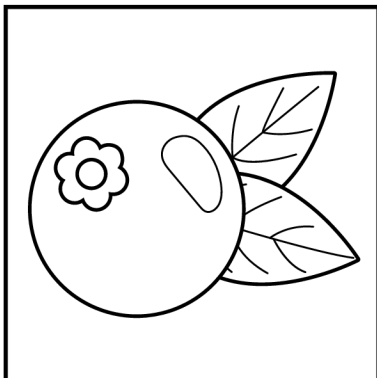

--	--	--

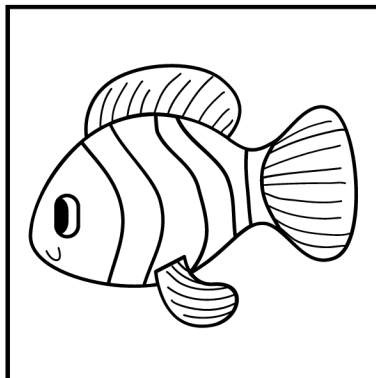

--	--	--

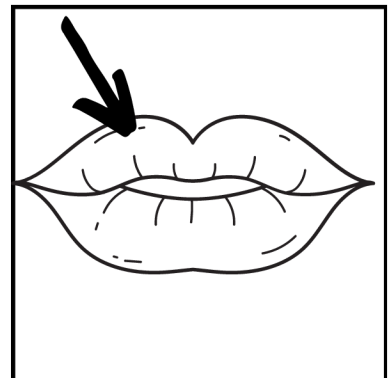

--	--	--

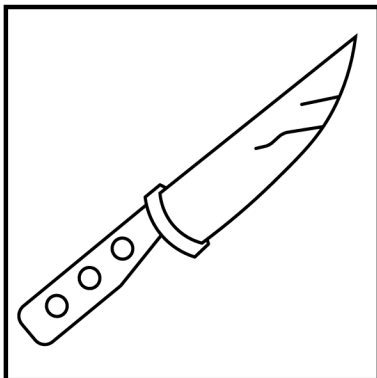

--	--	--



--	--	--

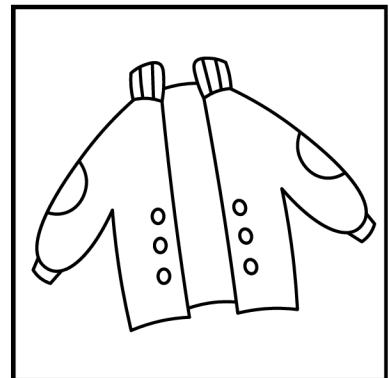

--	--	--

naam:.....

1. Schrijf de letter netjes over.



k k k k k k k k k . . . . .

2. Hoor je de letter 'k'? Zet een kruisje in het juiste vak.

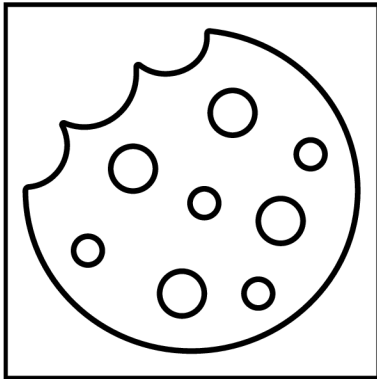

--	--	--

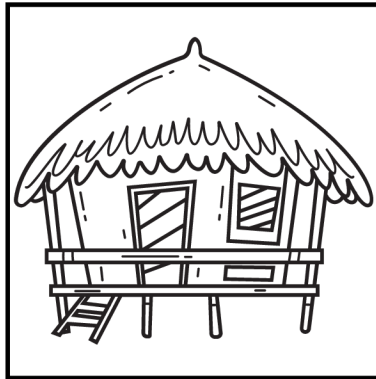

--	--	--

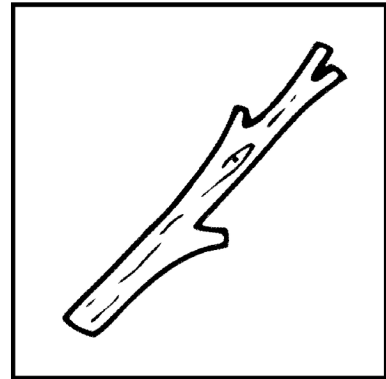

--	--	--

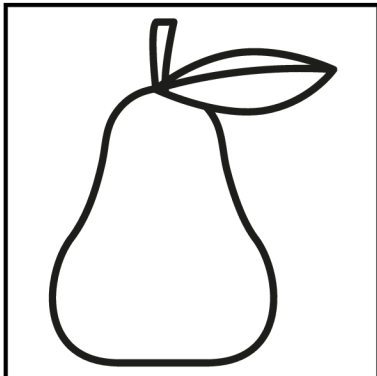

--	--	--

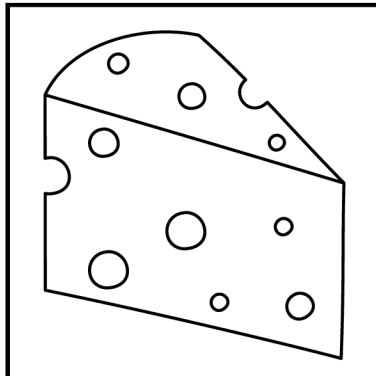

--	--	--

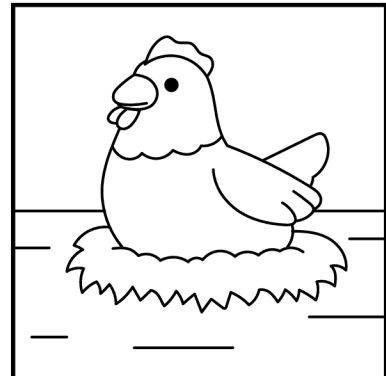

--	--	--

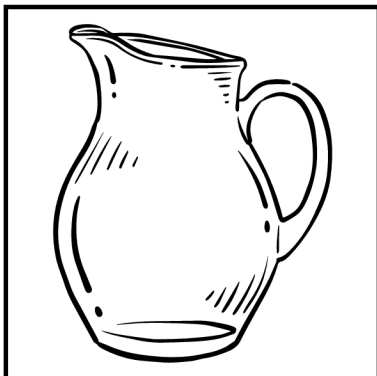

--	--	--

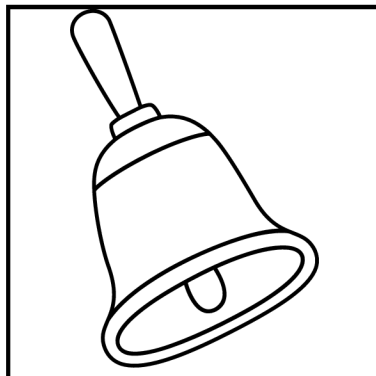

--	--	--

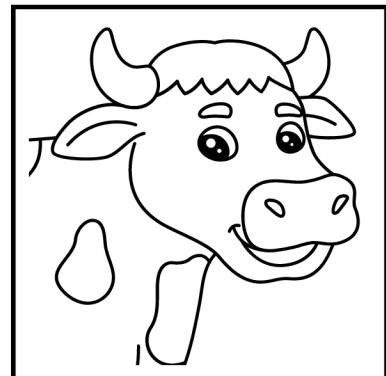

--	--	--

naam:.....



1. Schrijf de letter netjes over.



2. Hoor je de letter 'k'? Zet een kruisje in het juiste vak.

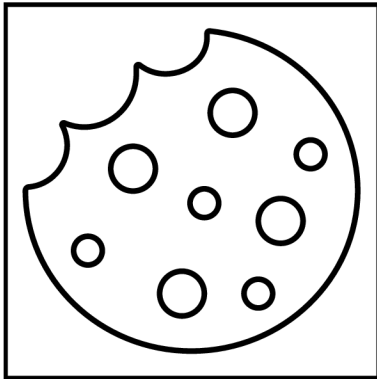

--	--	--

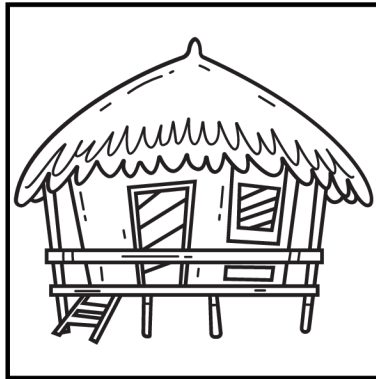

--	--	--

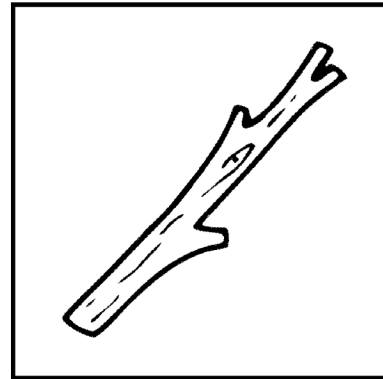

--	--	--

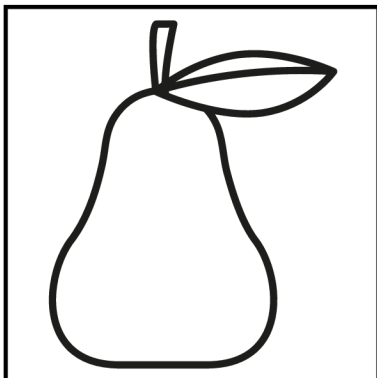

--	--	--

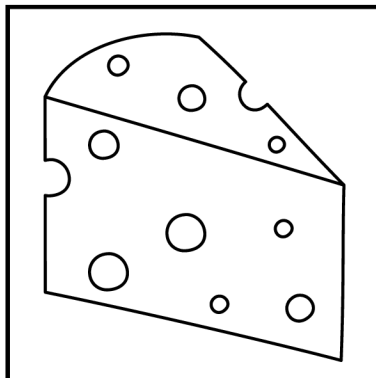

--	--	--

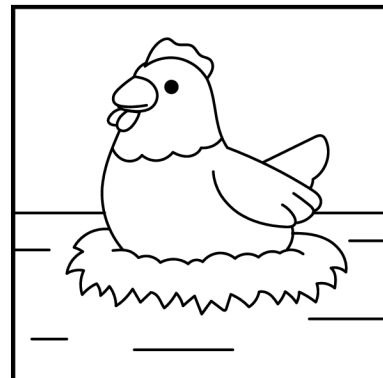

--	--	--



--	--	--

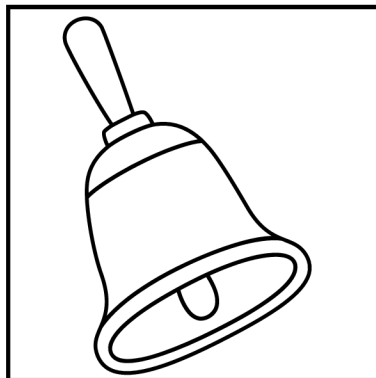

--	--	--

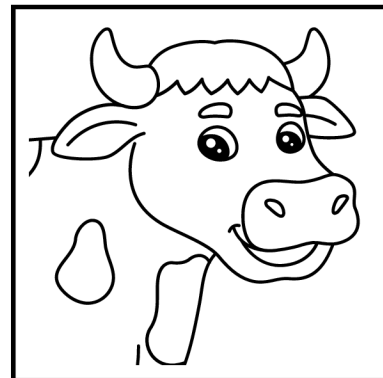

--	--	--

naam:.....

1. Schrijf de letter netjes over.



b b b b b b b b b . . . . .

2. Hoor je de letter 'b'? Zet een kruisje in het juiste vak.

b

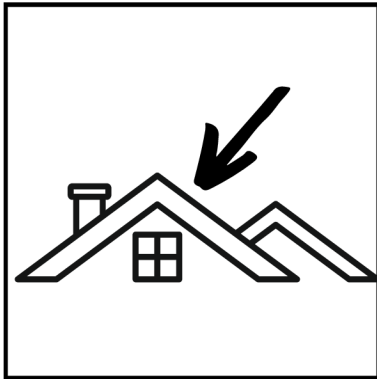

--	--	--

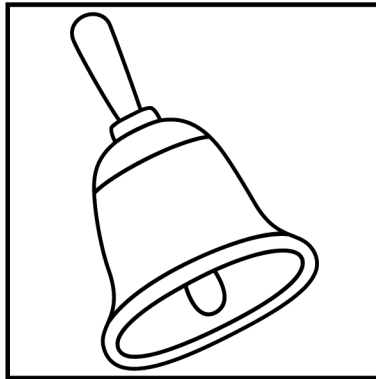

--	--	--

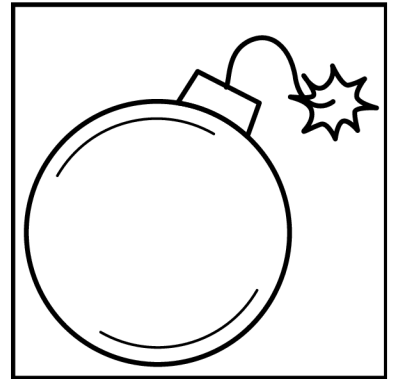

--	--	--

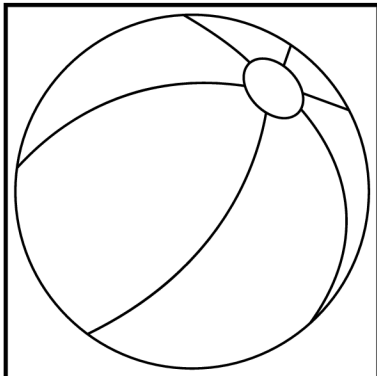

--	--	--

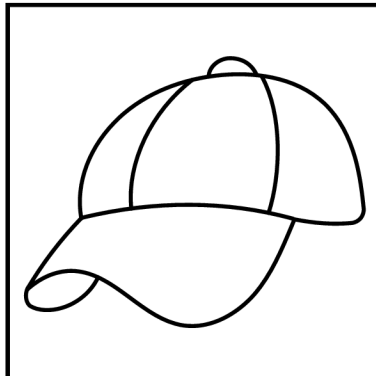

--	--	--

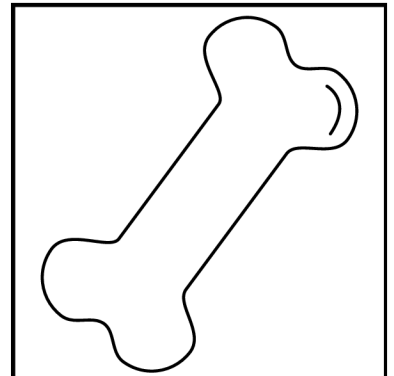

--	--	--

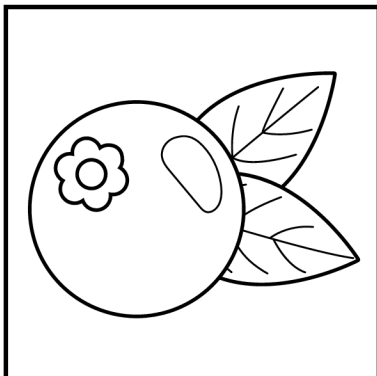

--	--	--

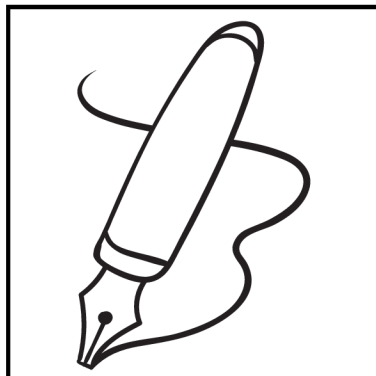

--	--	--

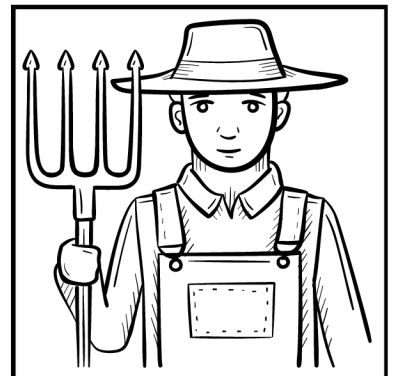

--	--	--

naam:.....

1. Schrijf de letter netjes over.



2. Hoor je de letter 'b'? Zet een kruisje in het juiste vak.

b

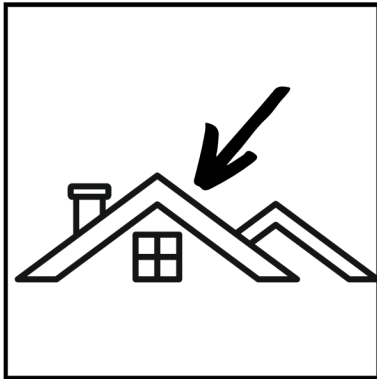

--	--	--

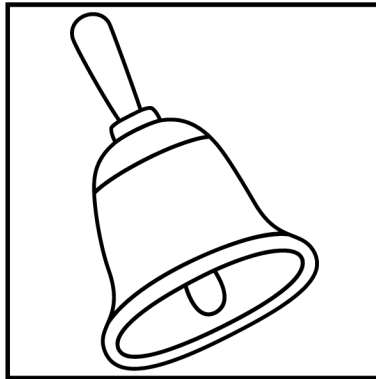

--	--	--

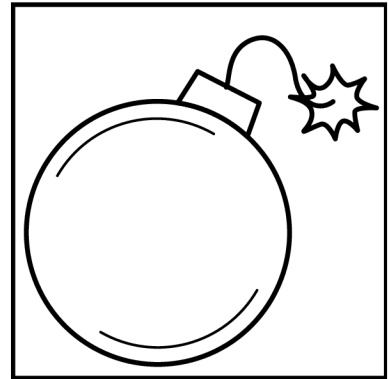

--	--	--

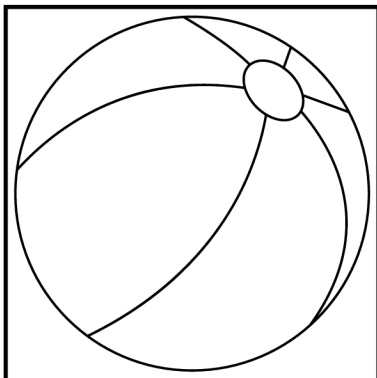

--	--	--

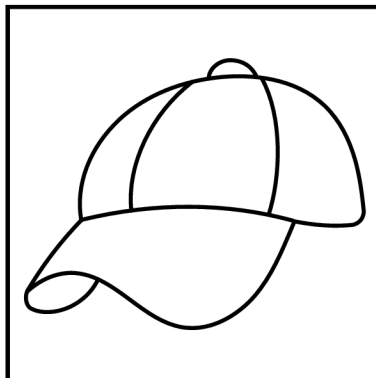

--	--	--

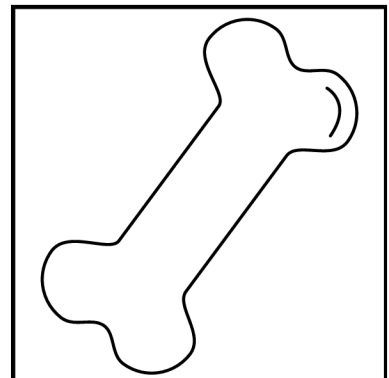

--	--	--

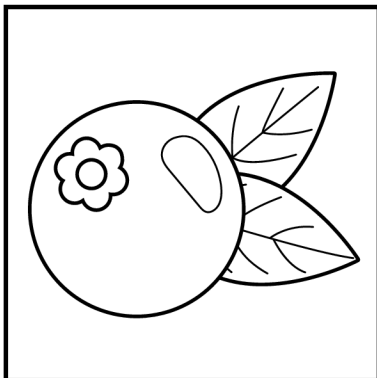

--	--	--

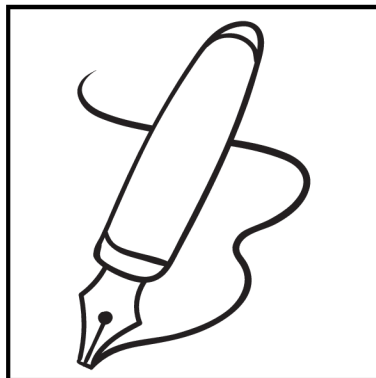

--	--	--

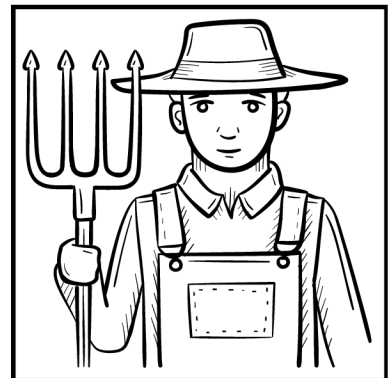

--	--	--

naam:.....

1. Schrijf de letter netjes over.



ll ll ll ll ll ll ll . . . . .

2. Hoor je de letter 'ee'? Zet een kruisje in het juiste vak.

ee

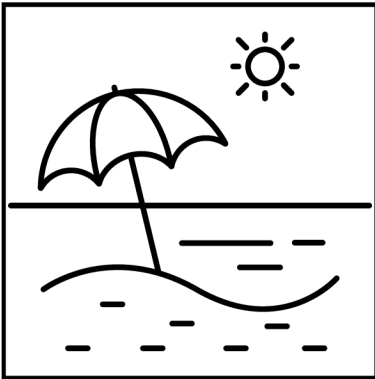

--	--

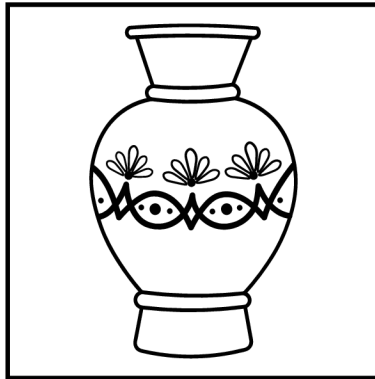

--	--	--

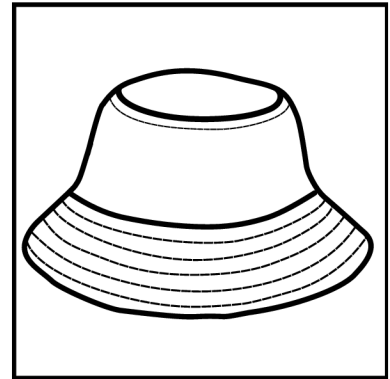

--	--	--

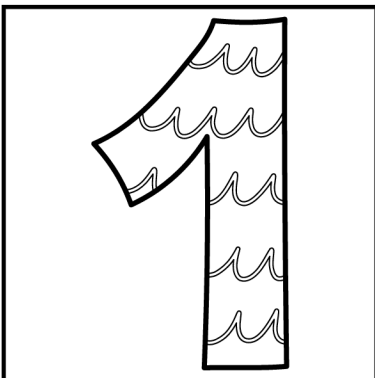

--	--

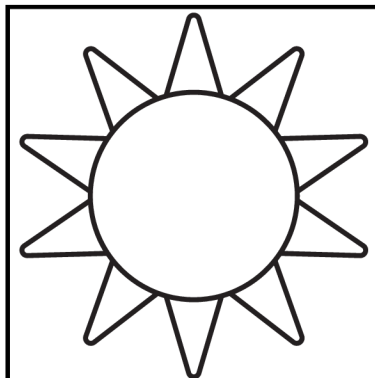

--	--	--

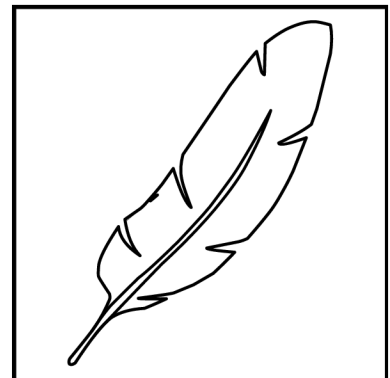

--	--	--

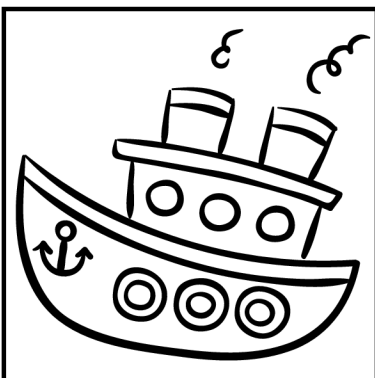

--	--	--

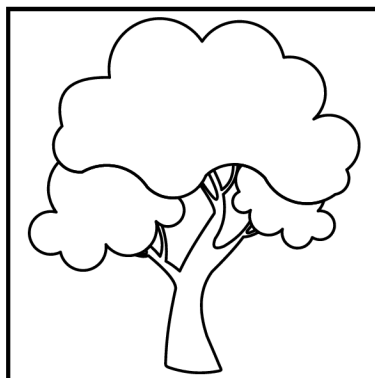

--	--	--

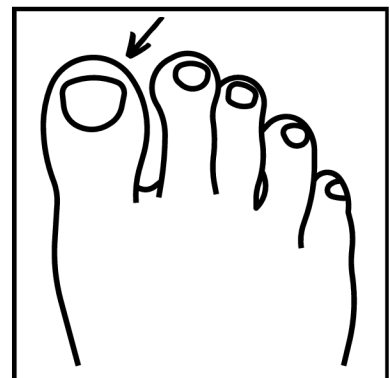

--	--	--

naam:.....

1. Schrijf de letter netjes over.



ee ee ee ee ee ee ee . . . . .

2. Hoor je de letter 'ee'? Zet een kruisje in het juiste vak.

ee

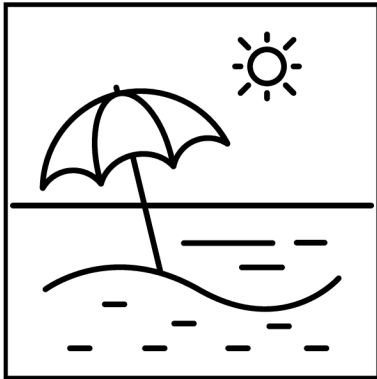

--	--

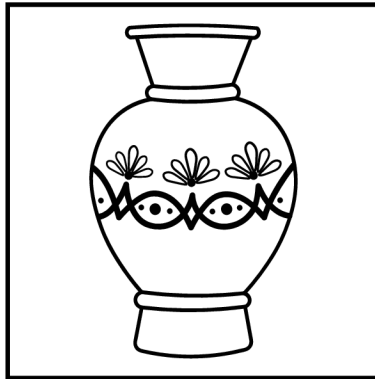

--	--	--

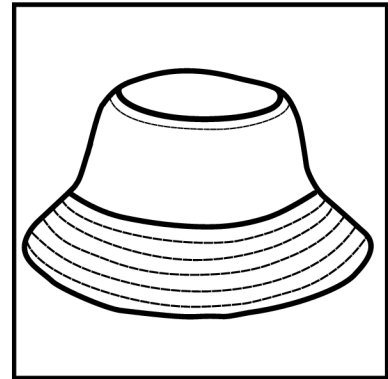

--	--	--

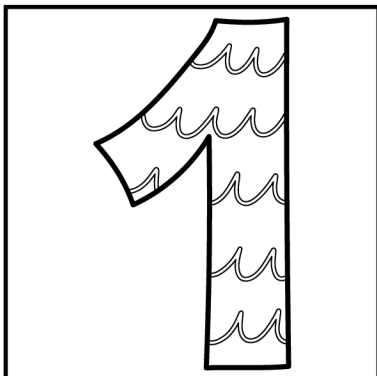

--	--

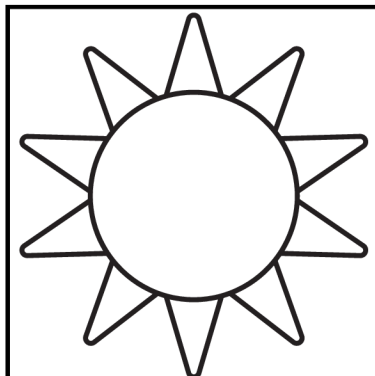

--	--	--

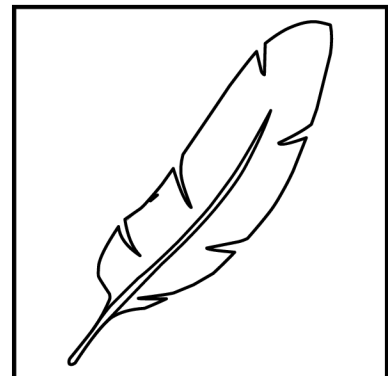

--	--	--

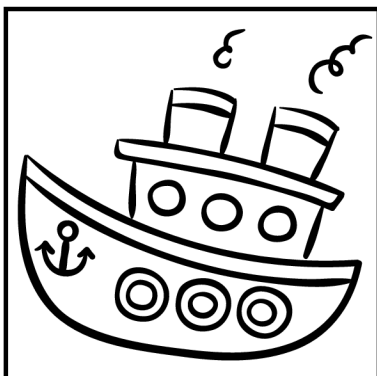

--	--	--

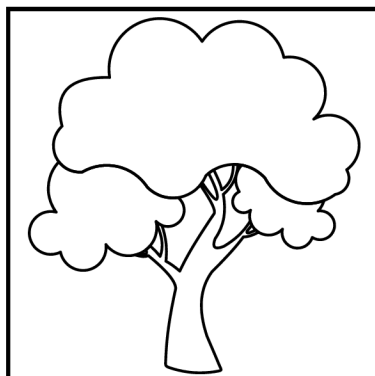

--	--	--

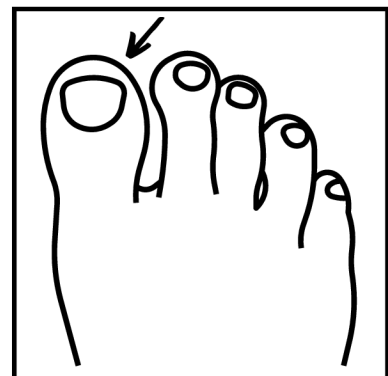

--	--	--



naam:.....

1. Schrijf de letter netjes over.



r r r r r r r r r . . . . .

2. Hoor je de letter 'r'? Zet een kruisje in het juiste vak.

r

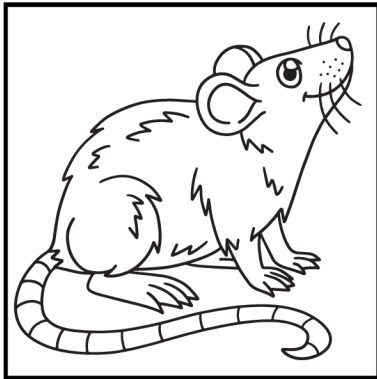

--	--	--

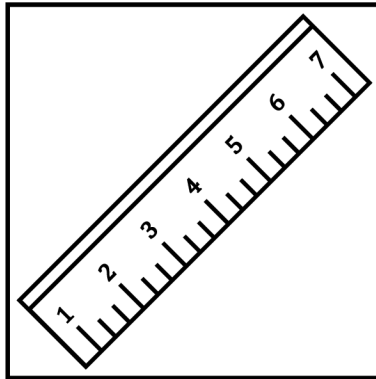

--	--	--

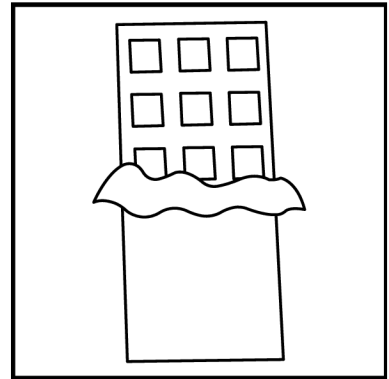

--	--	--

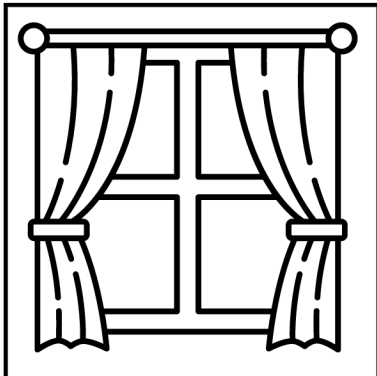

--	--	--

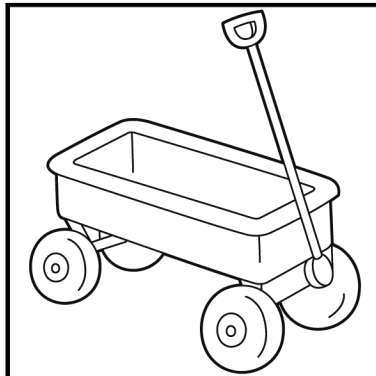

--	--	--

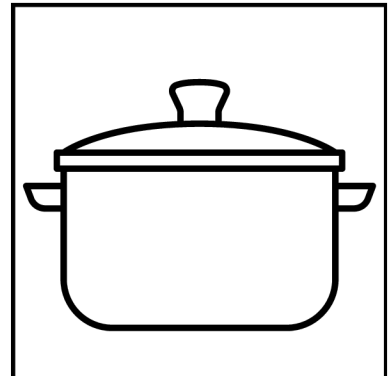

--	--	--

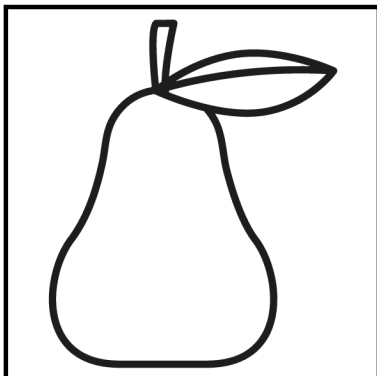

--	--	--



--	--	--

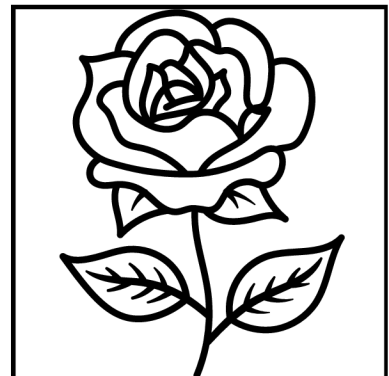

--	--	--

naam:.....

1. Schrijf de letter netjes over.



2. Hoor je de letter 'r'? Zet een kruisje in het juiste vak.

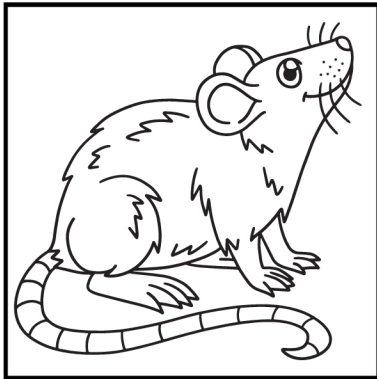

--	--	--

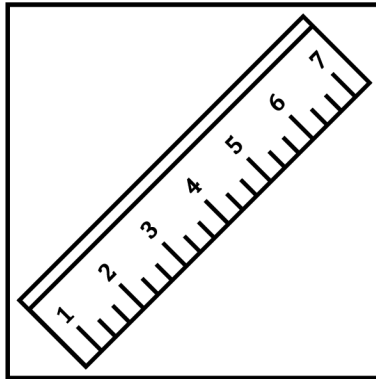

--	--	--

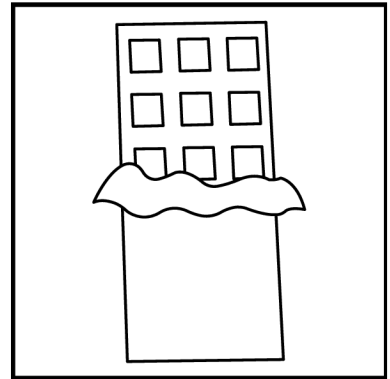

--	--	--

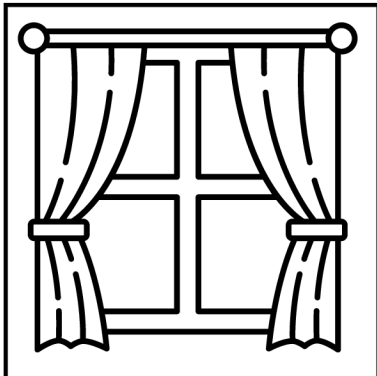

--	--	--

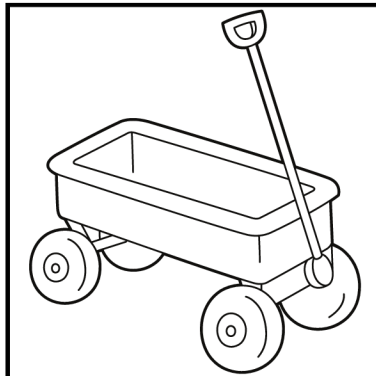

--	--	--

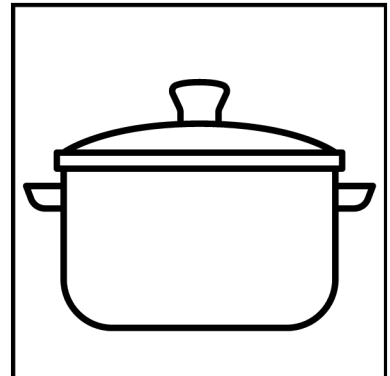

--	--	--

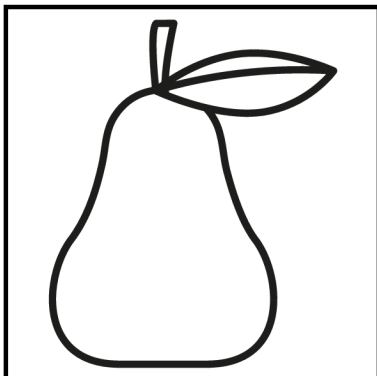

--	--	--



--	--	--

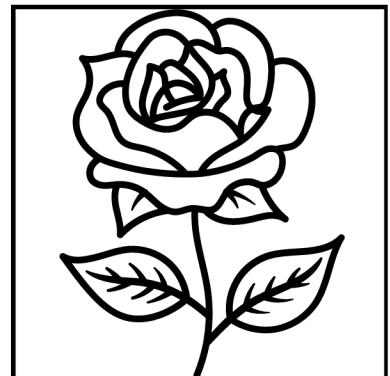

--	--	--

naam:.....

1. Schrijf de letter netjes over.



m m m m m m m . . . .

2. Hoor je de letter 'm'? Zet een kruisje in het juiste vak.

m

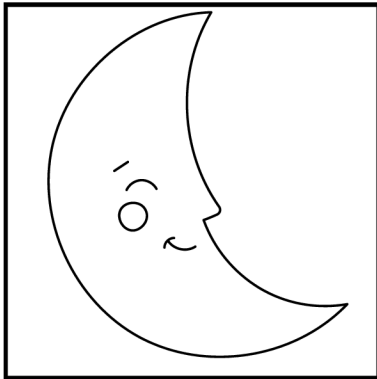

--	--	--

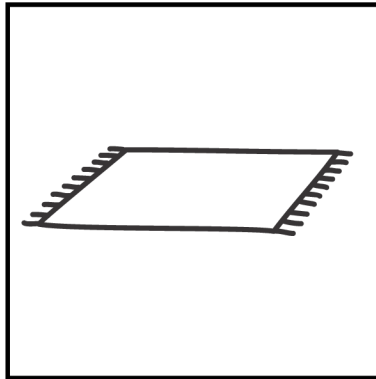

--	--	--

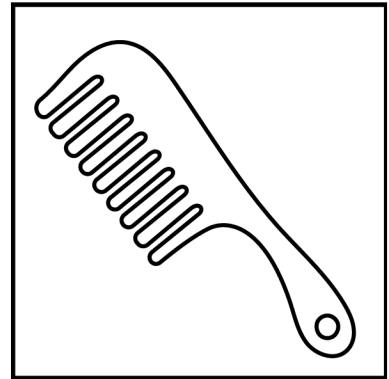

--	--	--

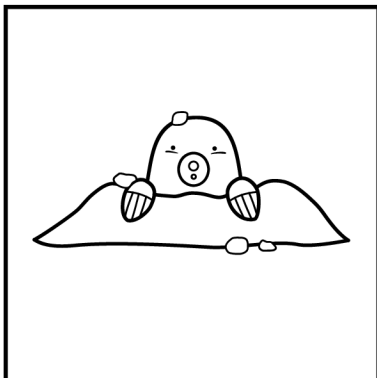

--	--	--

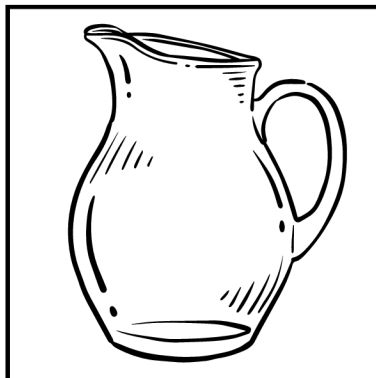

--	--	--

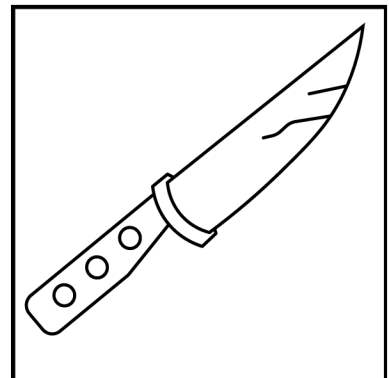

--	--	--

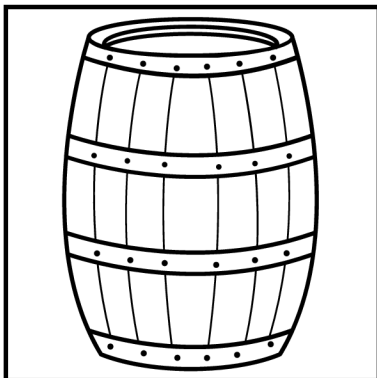

--	--	--

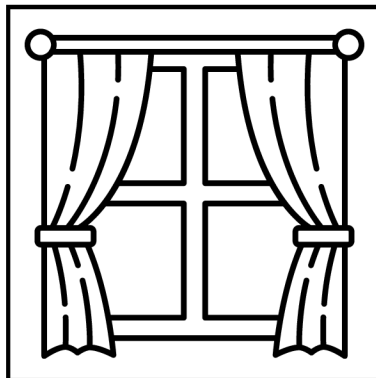

--	--	--

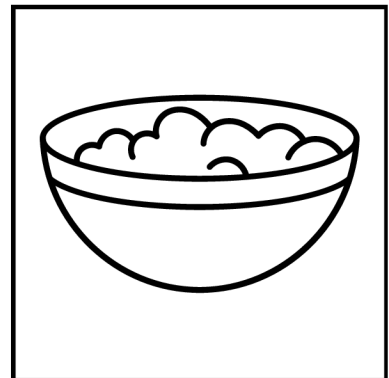

--	--	--

naam:.....

1. Schrijf de letter netjes over.



m m m m m m

2. Hoor je de letter 'm'? Zet een kruisje in het juiste vak.

m

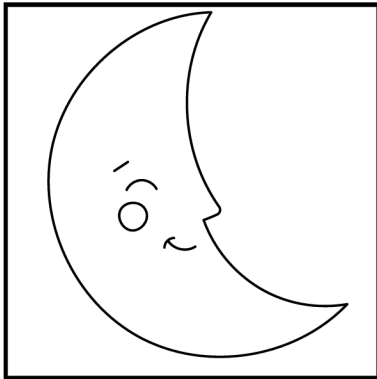

--	--	--

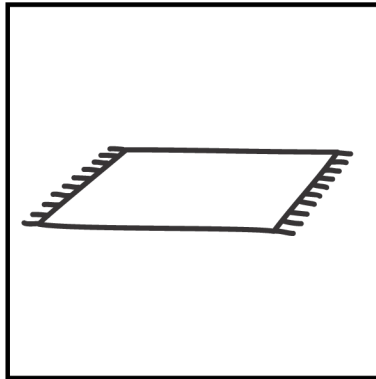

--	--	--

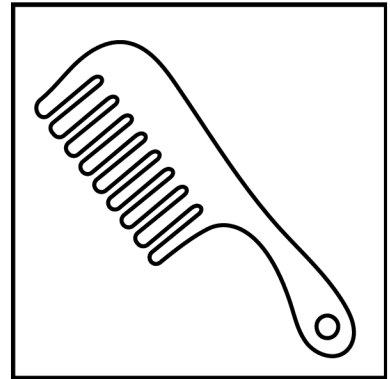

--	--	--

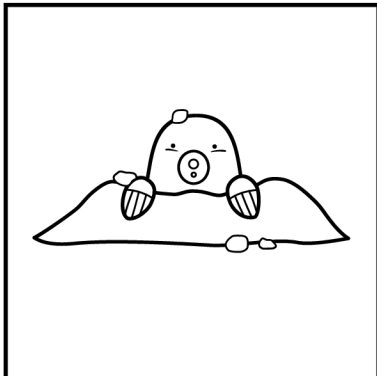

--	--	--

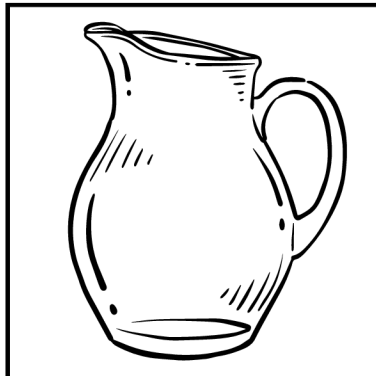

--	--	--

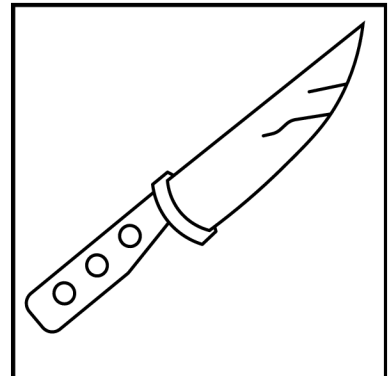

--	--	--

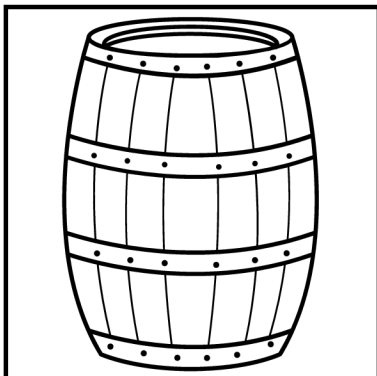

--	--	--

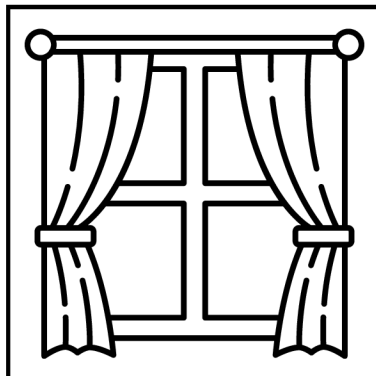

--	--	--

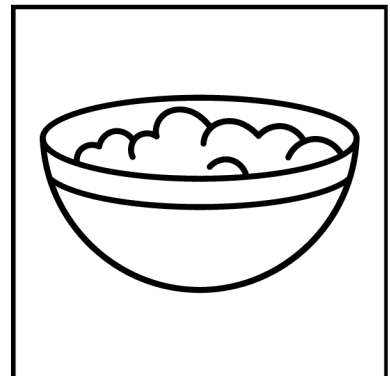

--	--	--

naam:.....

1. Schrijf de letter netjes over.



o o o o o o o o o o

2. Hoor je de letter 'o'? Zet een kruisje in het juiste vak.

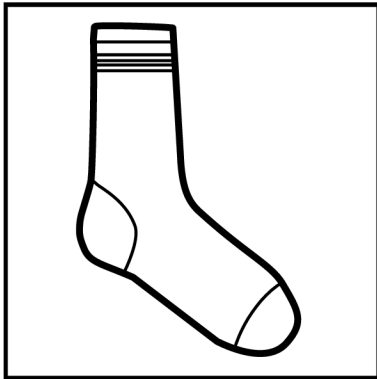

--	--	--

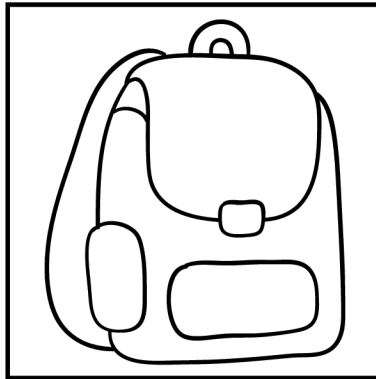

--	--	--

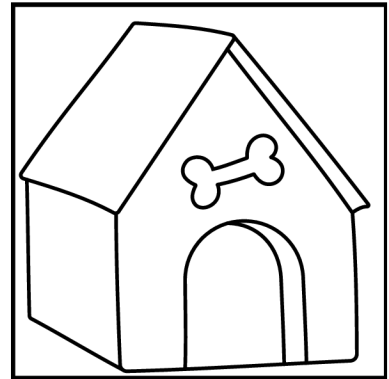

--	--	--

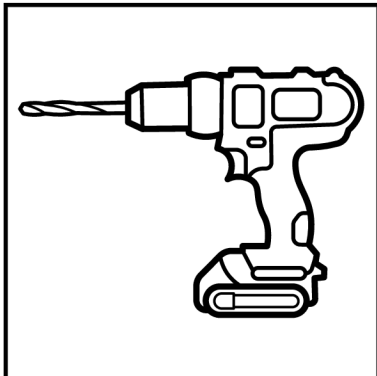

--	--	--

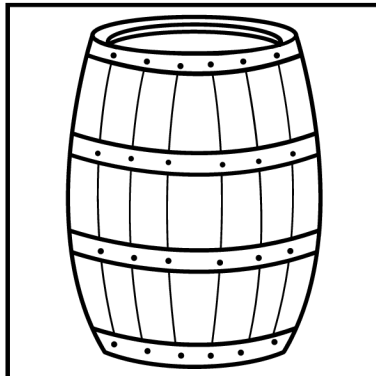

--	--	--

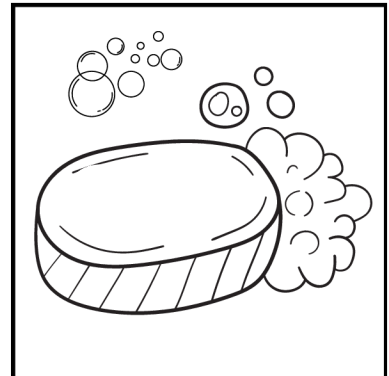

--	--	--

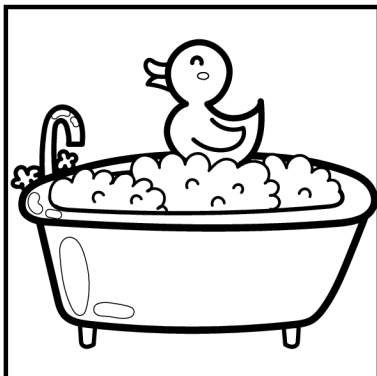

--	--	--

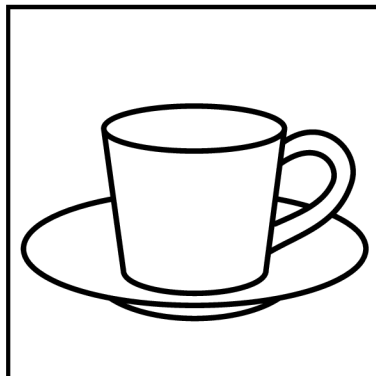

--	--	--

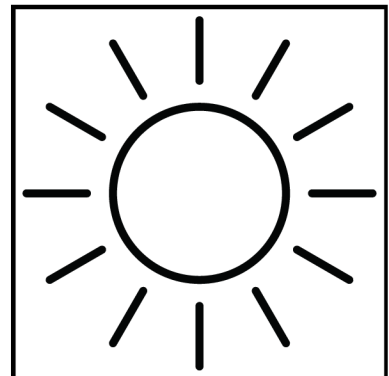

--	--	--

naam:.....

# 1. Schrijf de letter netjes over.



O O O O O O O O O O O O O

# 2. Hoor je de letter 'o'? Zet een kruisje in het juiste vak.

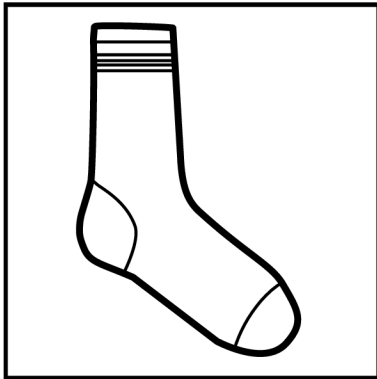

--	--	--

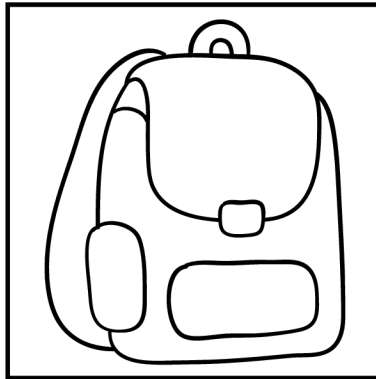

--	--	--

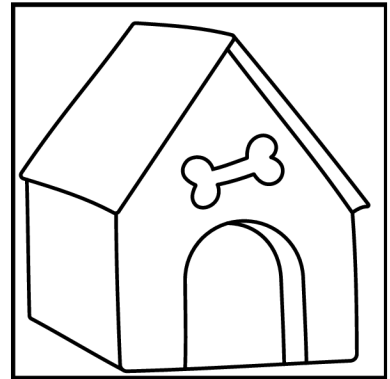

--	--	--

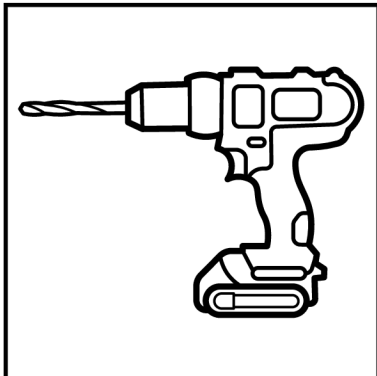

--	--	--

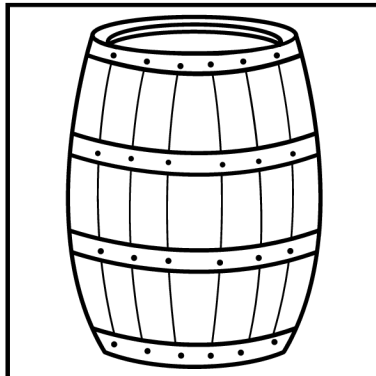

--	--	--

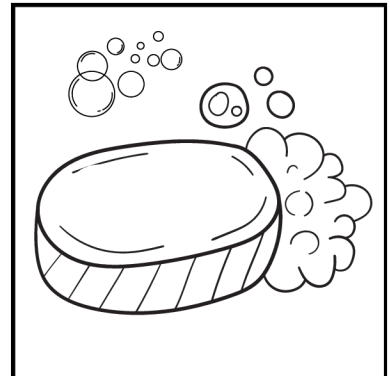

--	--	--

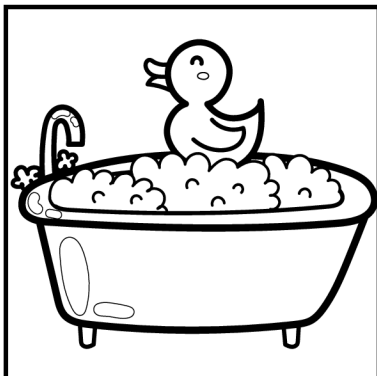

--	--	--

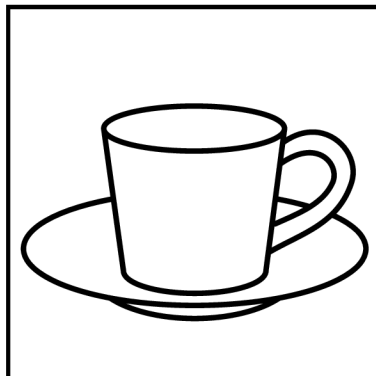

--	--	--

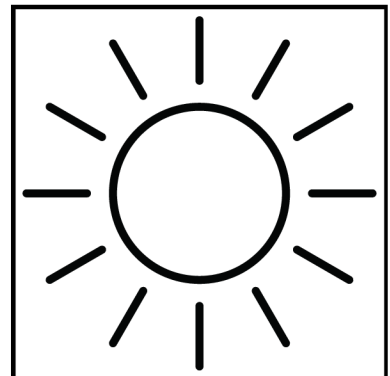

--	--	--

naam:.....

1. Schrijf de letter netjes over.

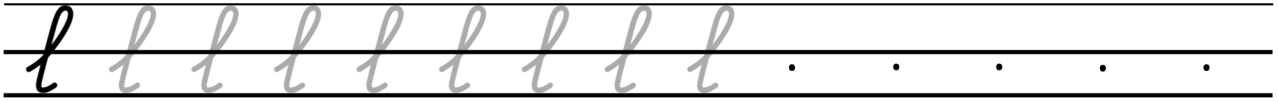

2. Hoor je de letter 'l'? Zet een kruisje in het juiste vak.

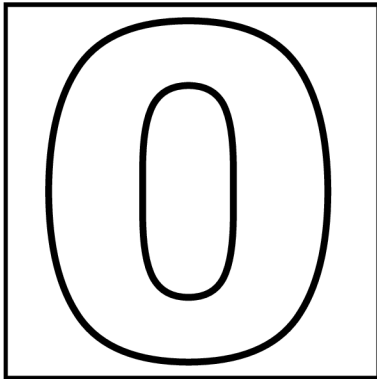

--	--	--

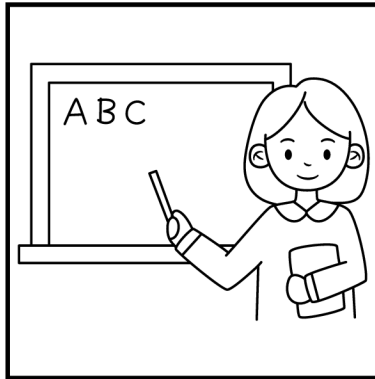

--	--	--

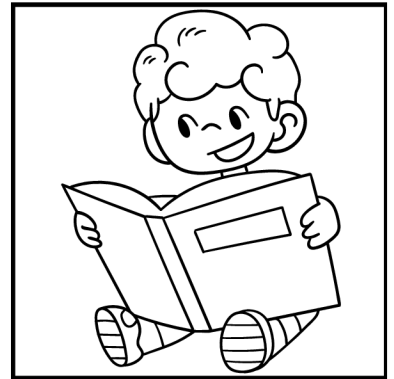

--	--	--

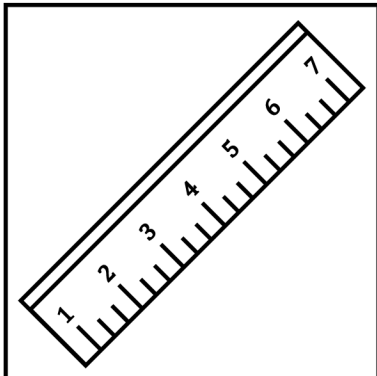

--	--	--



--	--	--

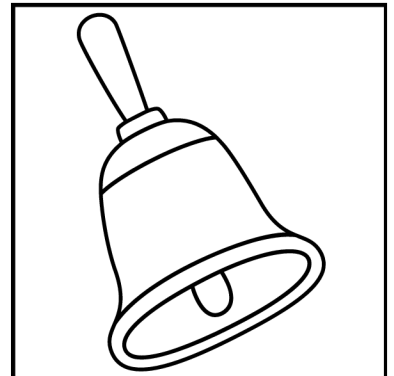

--	--	--

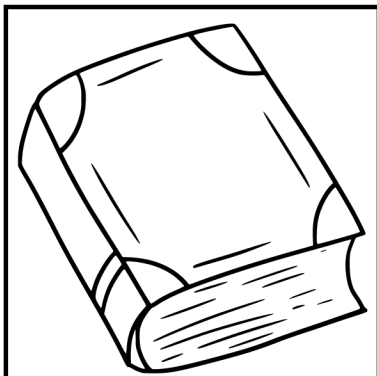

--	--	--

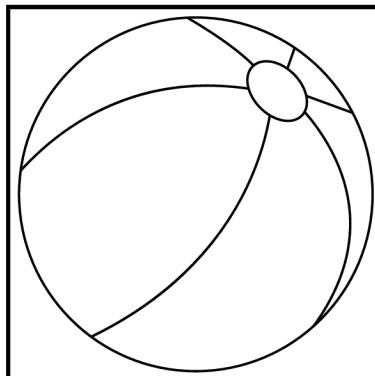

--	--	--

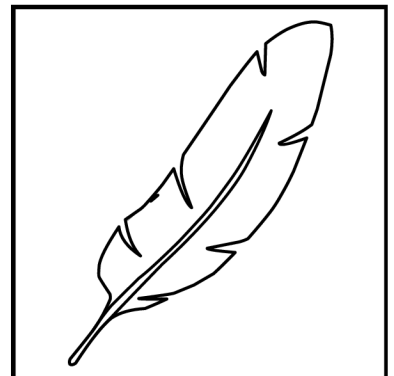

--	--	--

naam:.....

1. Schrijf de letter netjes over.



2. Hoor je de letter 'l'? Zet een kruisje in het juiste vak.

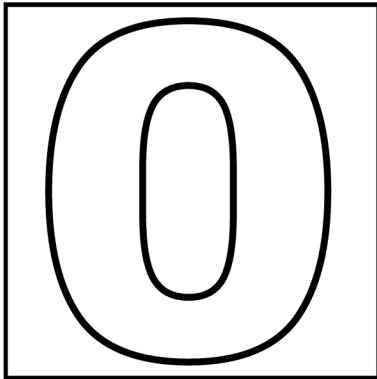

--	--	--

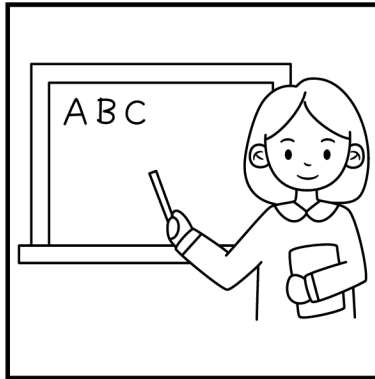

--	--	--

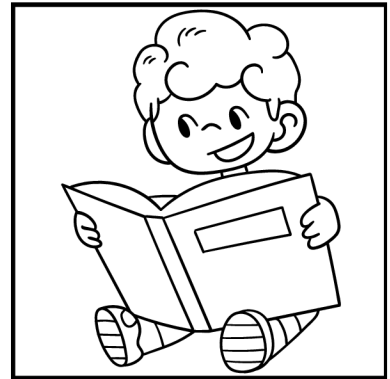

--	--	--

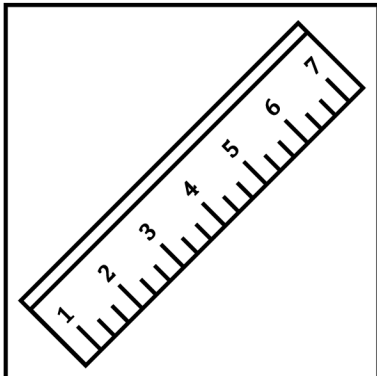

--	--	--



--	--	--

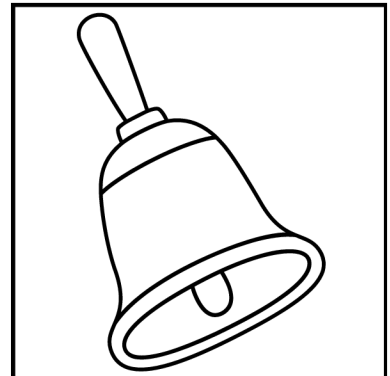

--	--	--

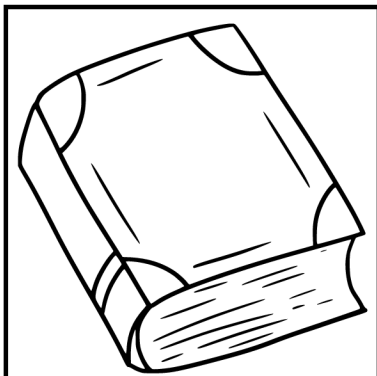

--	--	--

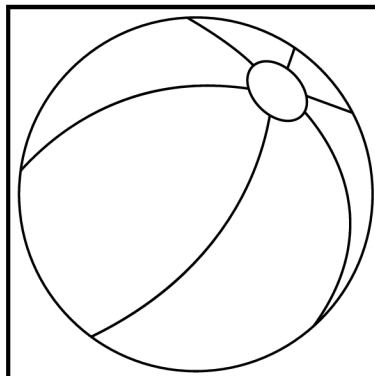

--	--	--

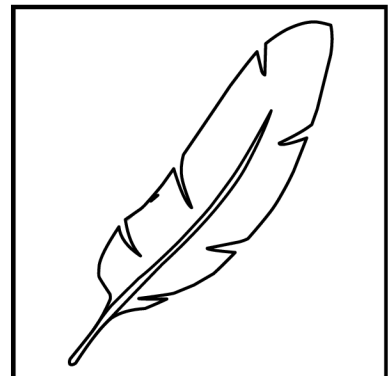

--	--	--



naam:.....

# 1. Schrijf de letter netjes over.



a a a a a a a a a

# 2. Hoor je de letter 'a'? Zet een kruisje in het juiste vak.



--	--	--

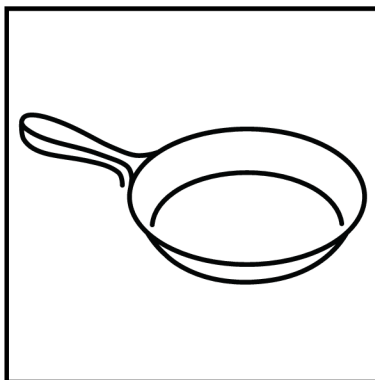

--	--	--

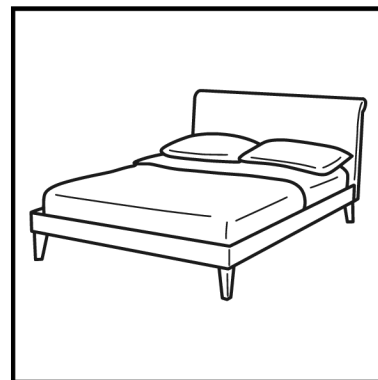

--	--	--

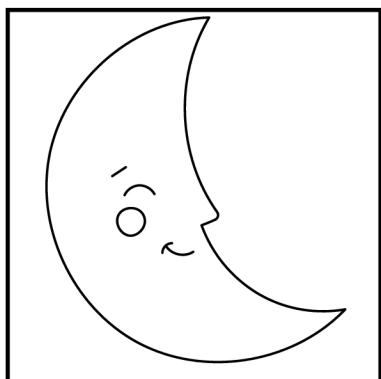

--	--	--

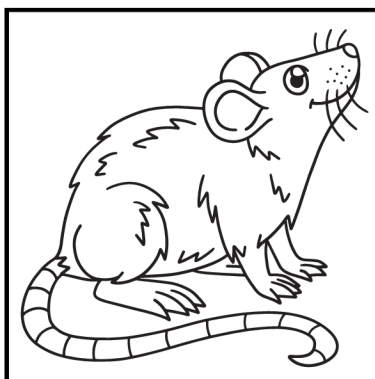

--	--	--

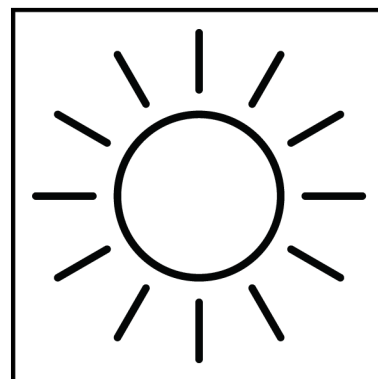

--	--	--

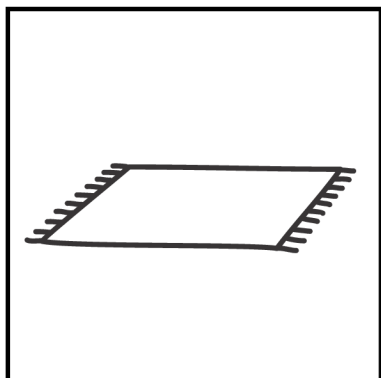

--	--	--

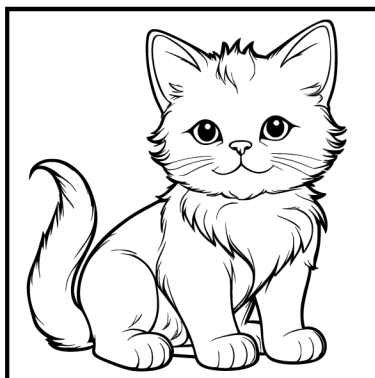

--	--	--

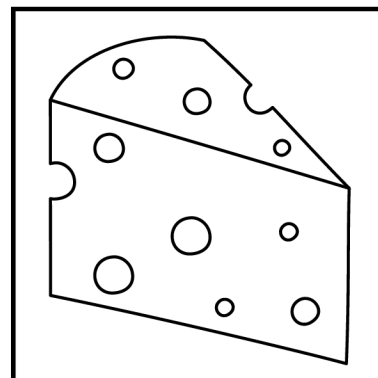

--	--	--

naam:.....

1. Schrijf de letter netjes over.



a a a a a a a a a a

2. Hoor je de letter 'a'? Zet een kruisje in het juiste vak.

a



--	--	--

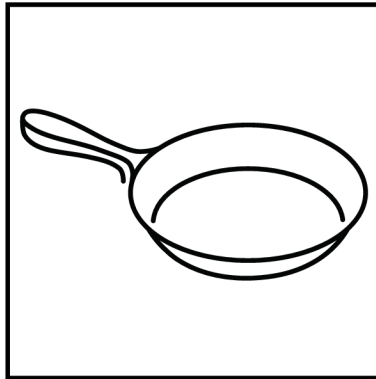

--	--	--

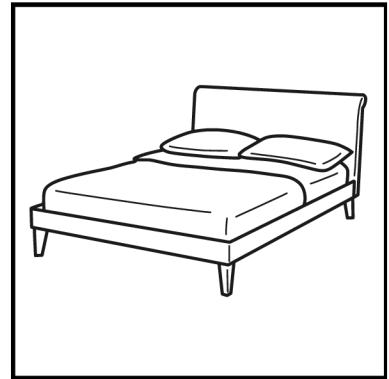

--	--	--

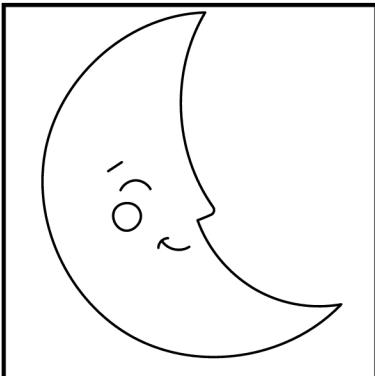

--	--	--

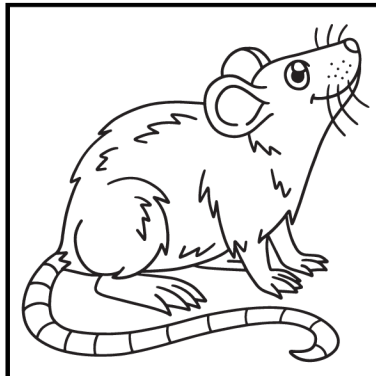

--	--	--

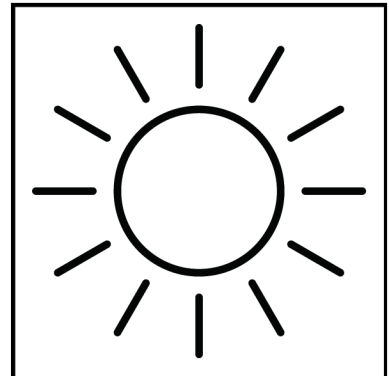

--	--	--

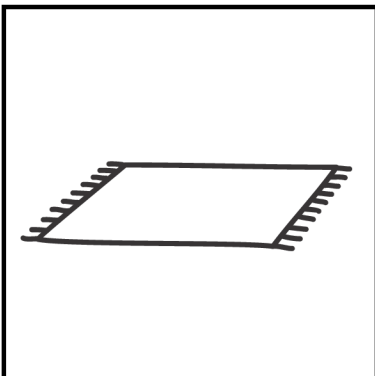

--	--	--

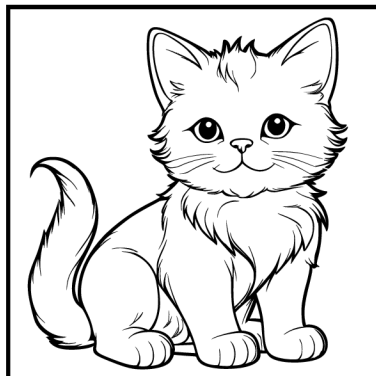

--	--	--

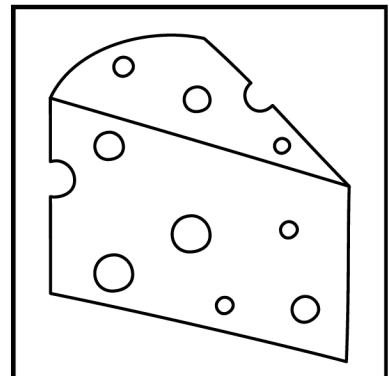

--	--	--

naam:.....

1. Schrijf de letter netjes over.



n n n n n n n n . . . .

2. Hoor je de letter 'n'? Zet een kruisje in het juiste vak.

n

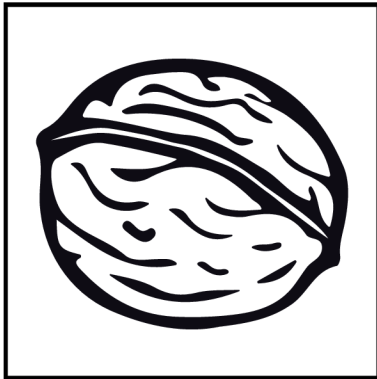

--	--	--

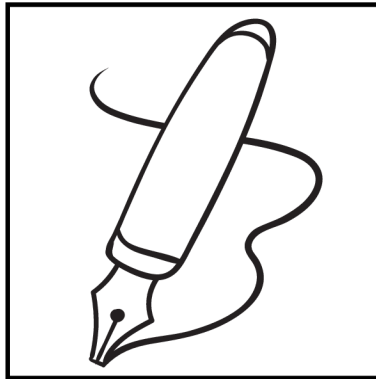

--	--	--

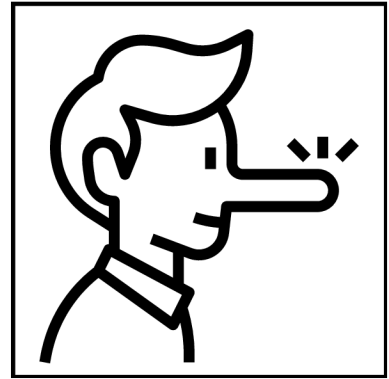

--	--	--

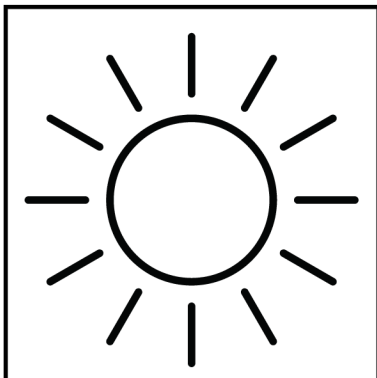

--	--	--

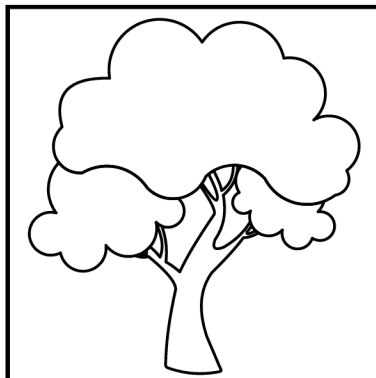

--	--	--

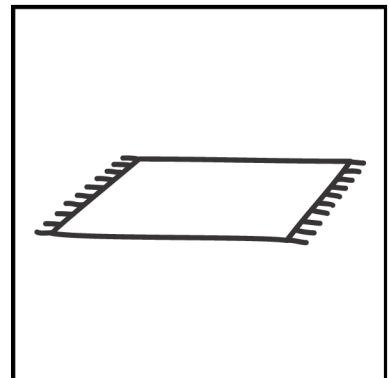

--	--	--

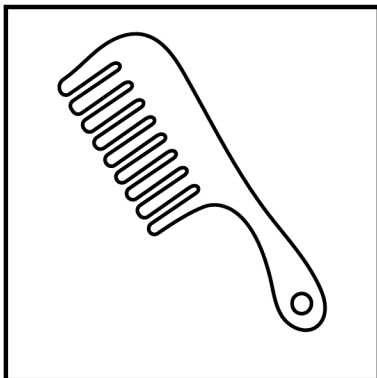

--	--	--

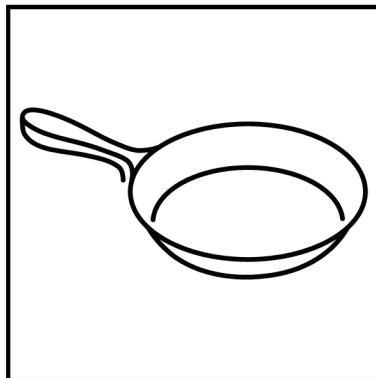

--	--	--

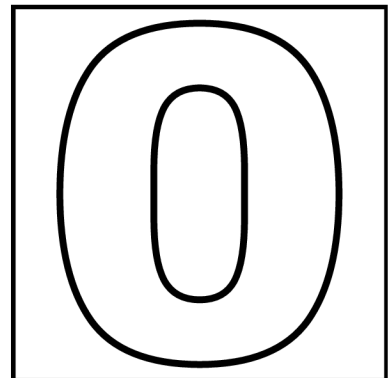

--	--	--

naam:.....

1. Schrijf de letter netjes over.



n n n n n n n . . . .

2. Hoor je de letter 'n'? Zet een kruisje in het juiste vak.

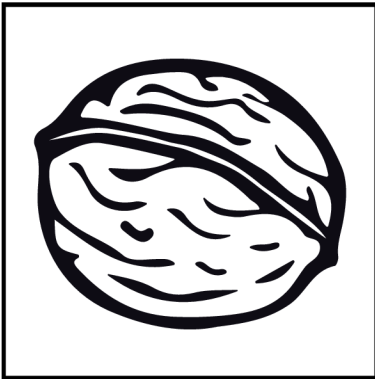

--	--	--

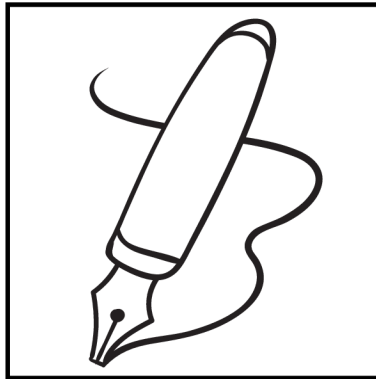

--	--	--

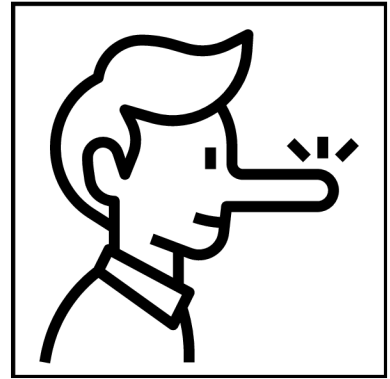

--	--	--

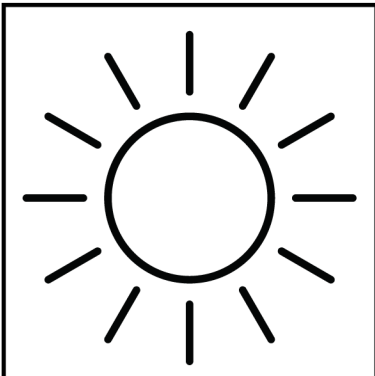

--	--	--

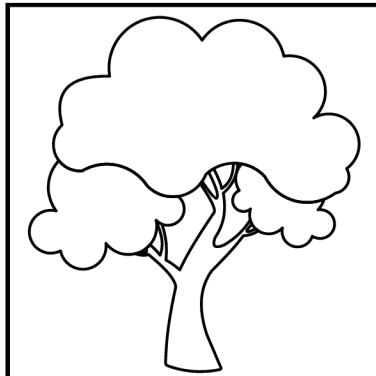

--	--	--

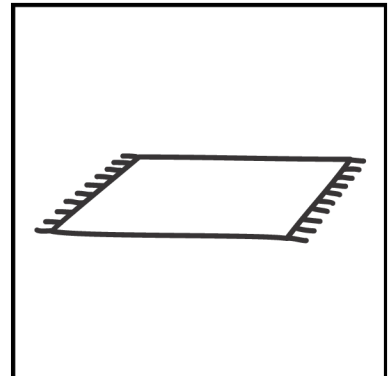

--	--	--

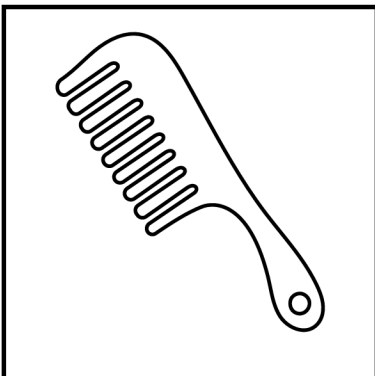

--	--	--

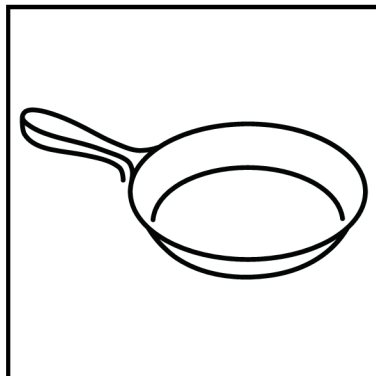

--	--	--

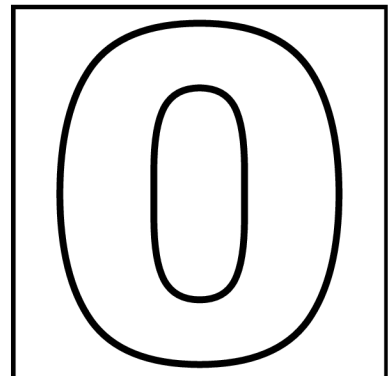

--	--	--

naam:.....

1. Schrijf de letter netjes over.



l l l l l l l l l . . . . .

2. Hoor je de letter 'e'? Zet een kruisje in het juiste vak.

e

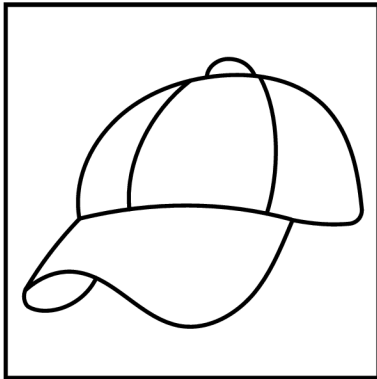

--	--	--

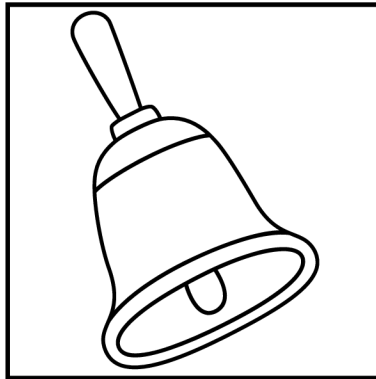

--	--	--

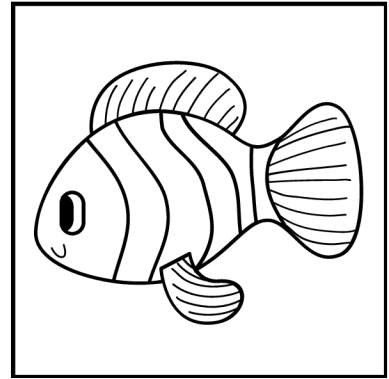

--	--	--

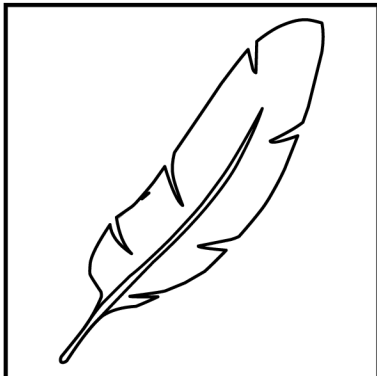

--	--	--

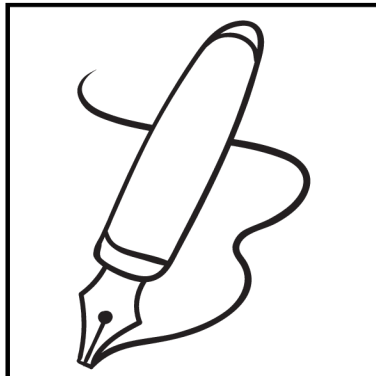

--	--	--

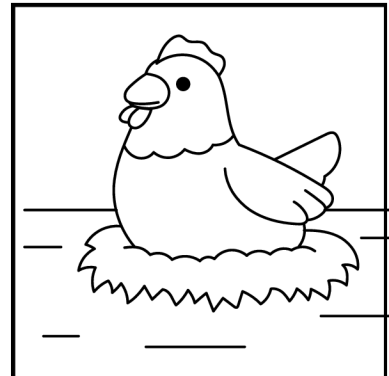

--	--	--

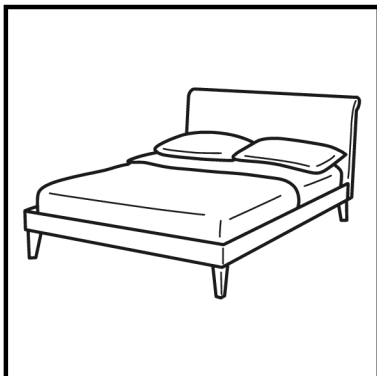

--	--	--

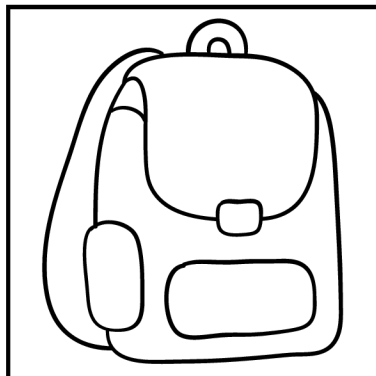

--	--	--

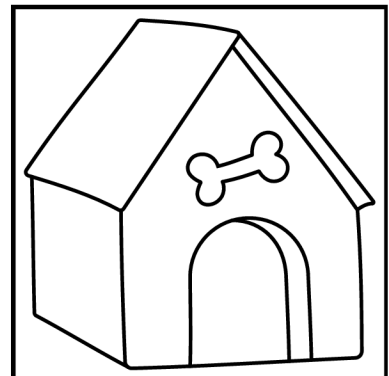

--	--	--